

888 INSTALLATION INSTRUCTIONS

A

CUTOUT

2 LIGHT

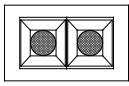

1 5/8" (41mm)

2 7/8" (75mm)

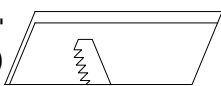

5 LIGHT

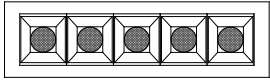

1 5/8" (41mm)

6 1/2" (166mm)

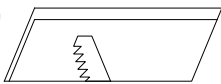

10 LIGHT

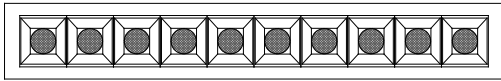

1 5/8" (41mm)

12 3/4" (323mm)

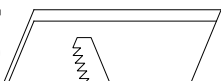

15 LIGHT

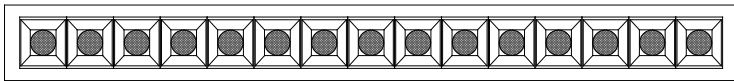

18 13/16" (478mm)

1 5/8" (41mm)

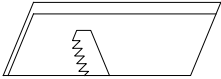

B

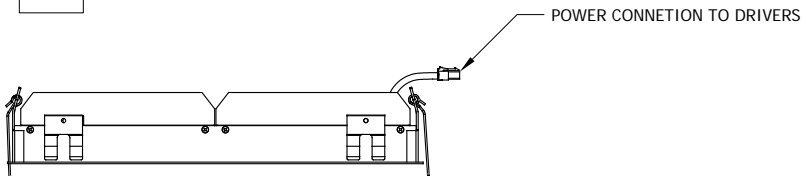

C

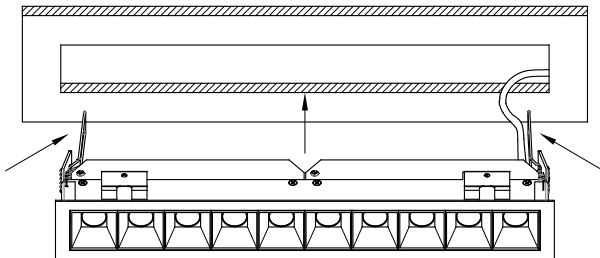

HOUSING INSTALLATION

THE FIXTURE IS FOR LED. FOLLOW THE STEPS AS SHOWN BELOW FOR INSTALLATION

BEFORE INSTALLATION, MAKE SURE THAT THE POWER SUPPLY IS OFF

A. MAKE CUTOUT IN CEILING FOR FIXTURE

B. MAKE POWER AND CONTROL CONNECTIONS TO FIXTURE

TEST WITH POWER

C. PUSH LATCHES BACK AND INSERT FIXTURE INTO CEILING

D. SEE FINISHED ASSEMBLY
IT IS RECOMMENDED THAT THESE PRODUCTS ARE INSTALLED BY A QUALIFIED ELECTRICIAN

D

FINISHED ASSEMBLY

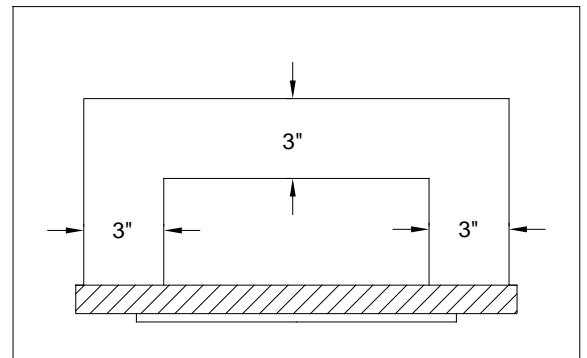
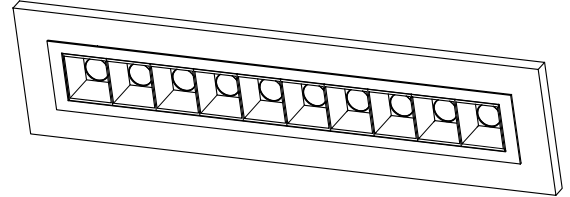

DO NOT INSTALL INSULATION WITHIN 3" (76mm) OF FIXTURE SIDES OR WIRING COMPARTMENT

